

The information on this page/document may no longer be current and is provided for educational and historical purposes. **You should not rely solely on this information.**

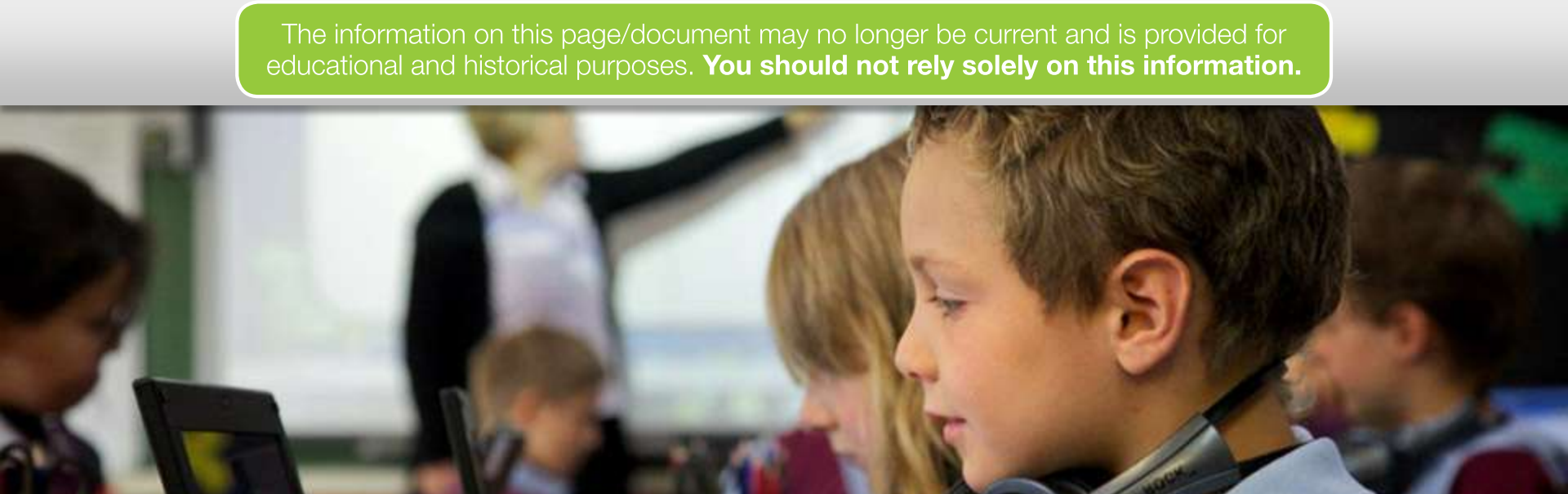

Address to ACCAN, “Our Broadband Future” 7 September 2011

Mike Quigley, National Broadband Network Company (NBN Co)

Disclaimer

This document sets out NBN Co's proposals in respect of certain aspects of the National Broadband Network. The contents of this document represent NBN Co's current position on the subject matter of this document. The contents of this document should not be relied upon by our stakeholders (or any other person) as representing NBN Co's final position on the subject matter of this document, except where stated otherwise. NBN Co's position on the subject matter of this document may also be impacted by legislative and regulatory developments in respect of the National Broadband Network.

All prices shown in this document are exclusive of any GST. © NBN Co Limited 2011



The information on this page/document may no longer be current and is provided for educational and historical purposes. **You should not rely solely on this information.**

National Broadband Network

93% Fibre + 7% (Wireless + Satellite)

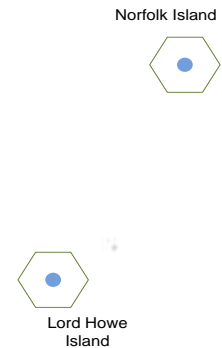
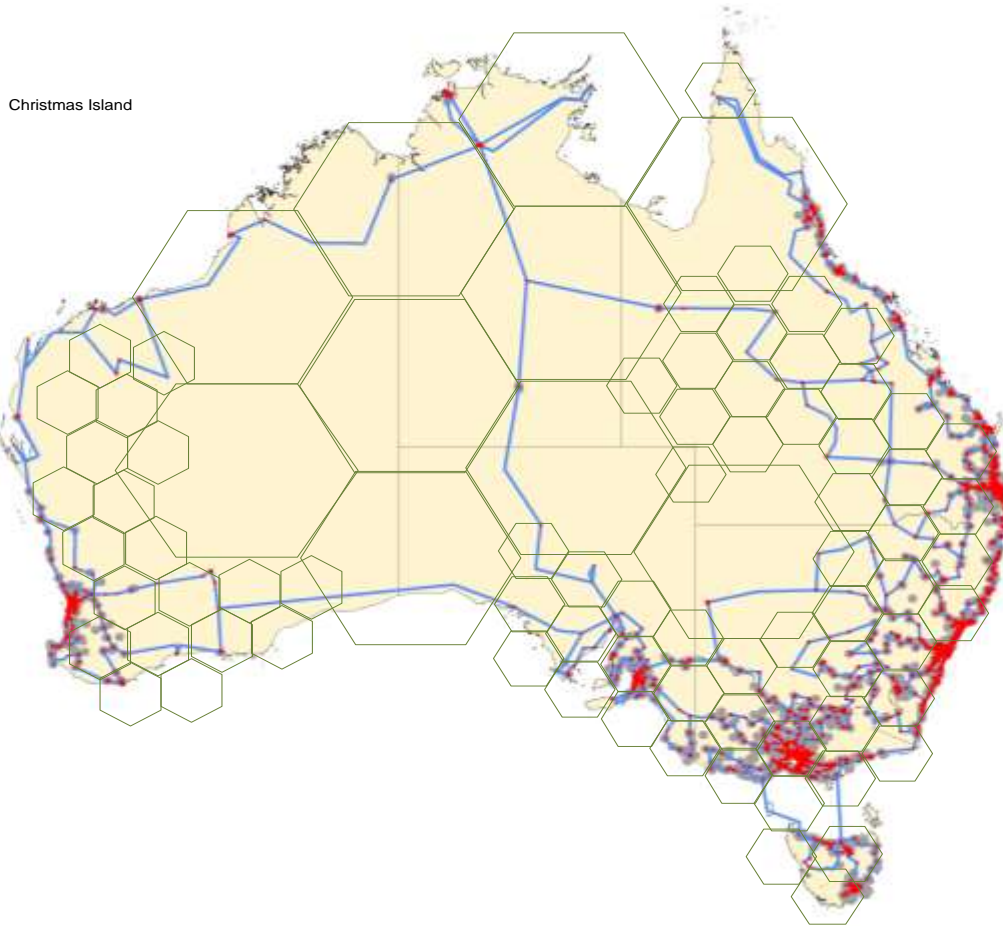
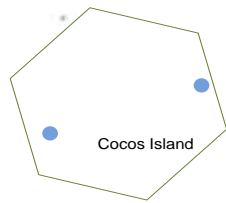

Indicative map

Legend:

- Grey Wireless coverage
- Red Fibre towns
- Blue Transit network
- Green Satellite coverage

The information on this page/document may no longer be current and is provided for educational and historical purposes. **You should not rely solely on this information.**

The Network Boundary Point

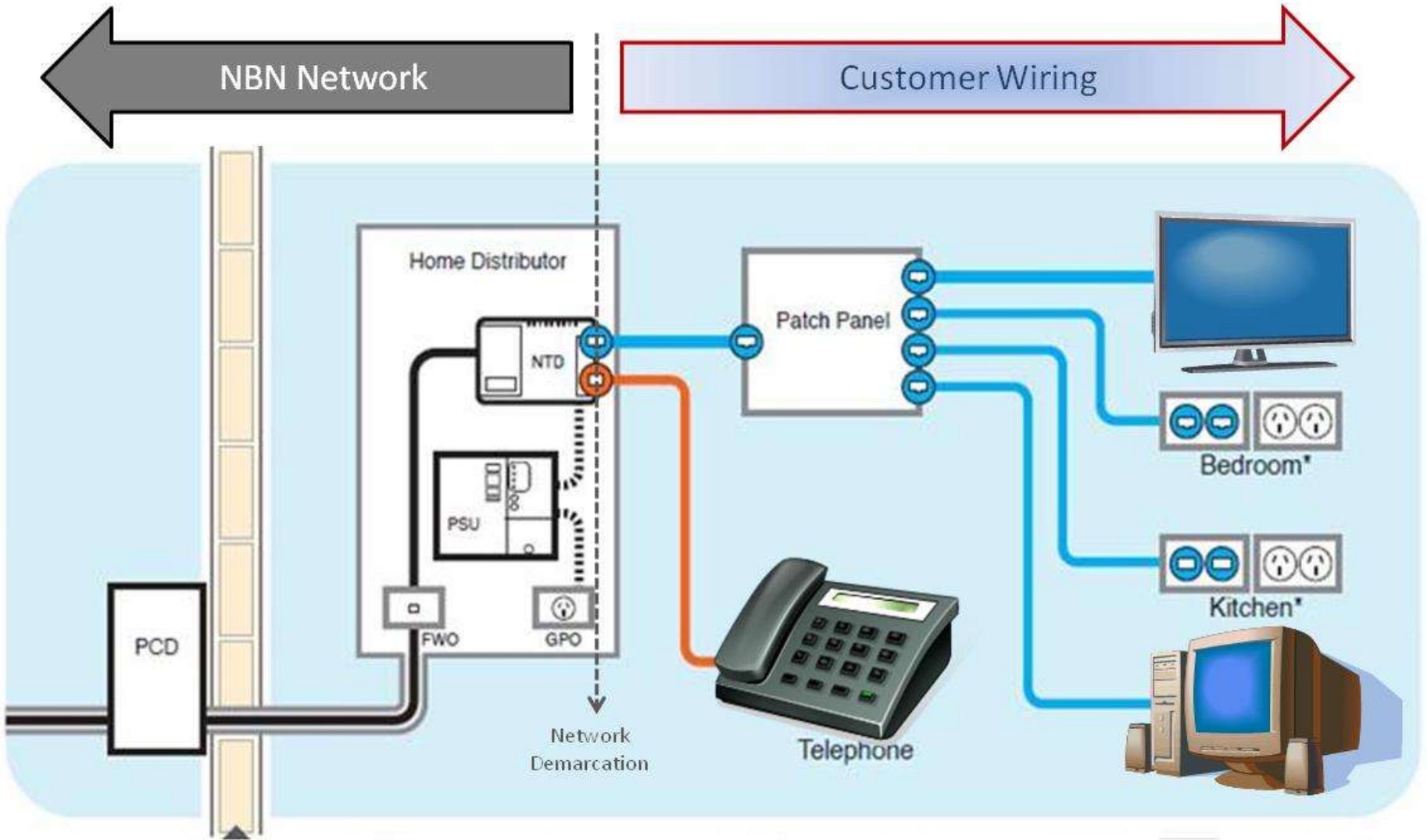

The information on this page/document may no longer be current and is provided for educational and historical purposes. **You should not rely solely on this information.**

NBN – Wholesale Only

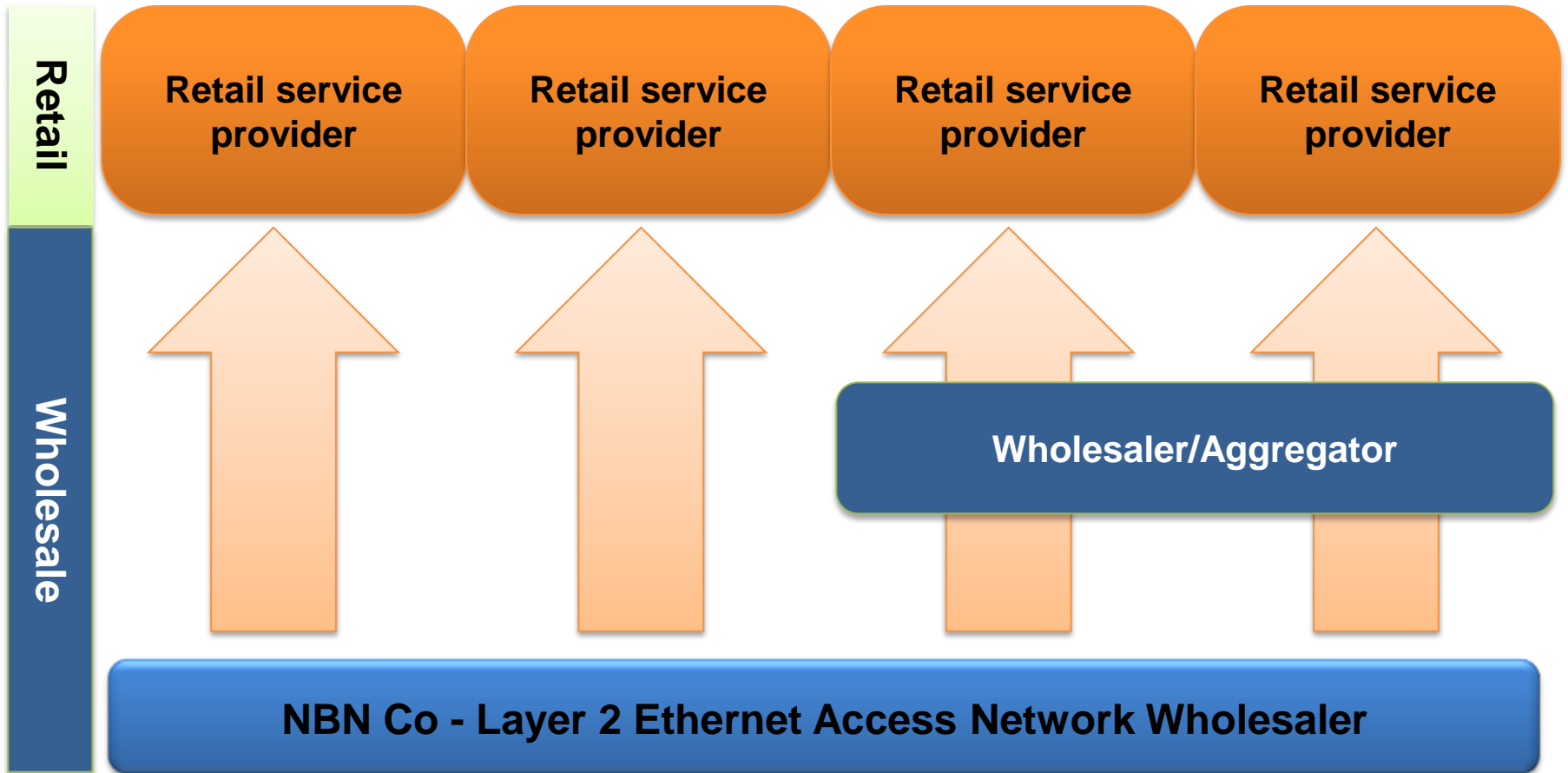

The information on this page/document may no longer be current and is provided for educational and historical purposes. **You should not rely solely on this information.**

Three technologies – one access seeker interface

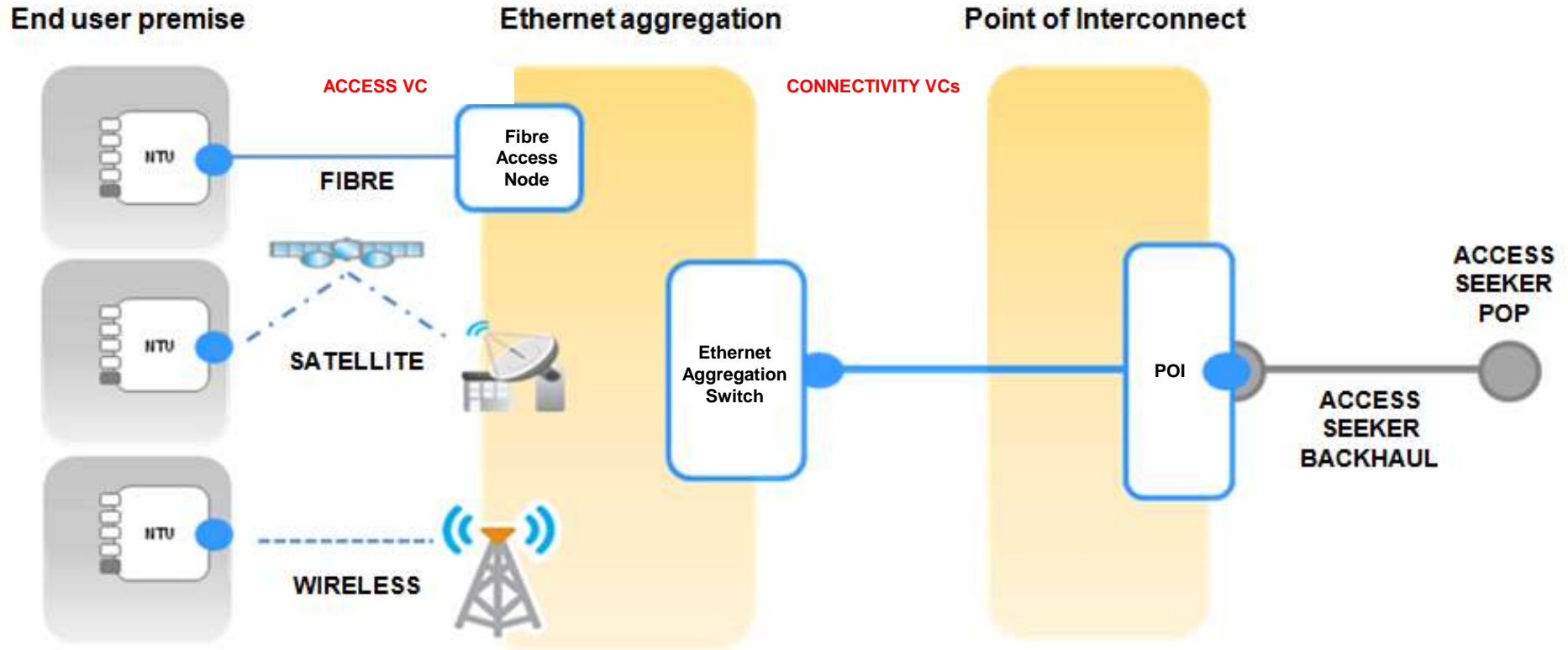

Public information on migration Activity

1

- Have advance notice of migration

2

- Know the actions needed to migrate

3

- Start the migration process before their existing service is decommissioned

Public information on migration activity

Easy-to-understand, easy-to-access information and education that ensures:

People maintain continuity of their service

When to migrate / how to migrate

The extent to which existing equipment is reusable

Physical home wiring that will need replacing/upgrading

The role and responsibilities of retail service providers (RSPs)

Australians are positioned to take advantage of the new capabilities on offer

The nature of services available

What those services will enable

The responsibility of consumers during migration

Migration Activity – Information Development

The activity will be developed with input from the Commonwealth, industry and consumers:

- in conjunction with the Commonwealth
- in consultation with Telstra
- involving key stakeholders including the ACCC and ACMA
- via engagement and consultation with the broader communications industry and industry consumer groups

The activity will be fully funded by NBN Co

Public information on migration. 3 Phases

**PHASE 1:
General
Awareness**

**PHASE 2:
Local
Awareness**

**PHASE 3:
Specific
Customer
Awareness**

RSP NEUTRAL

The information on this page/document may no longer be current and is provided for educational and historical purposes. **You should not rely solely on this information.**

Network Termination Device

Example only: NTD indoor

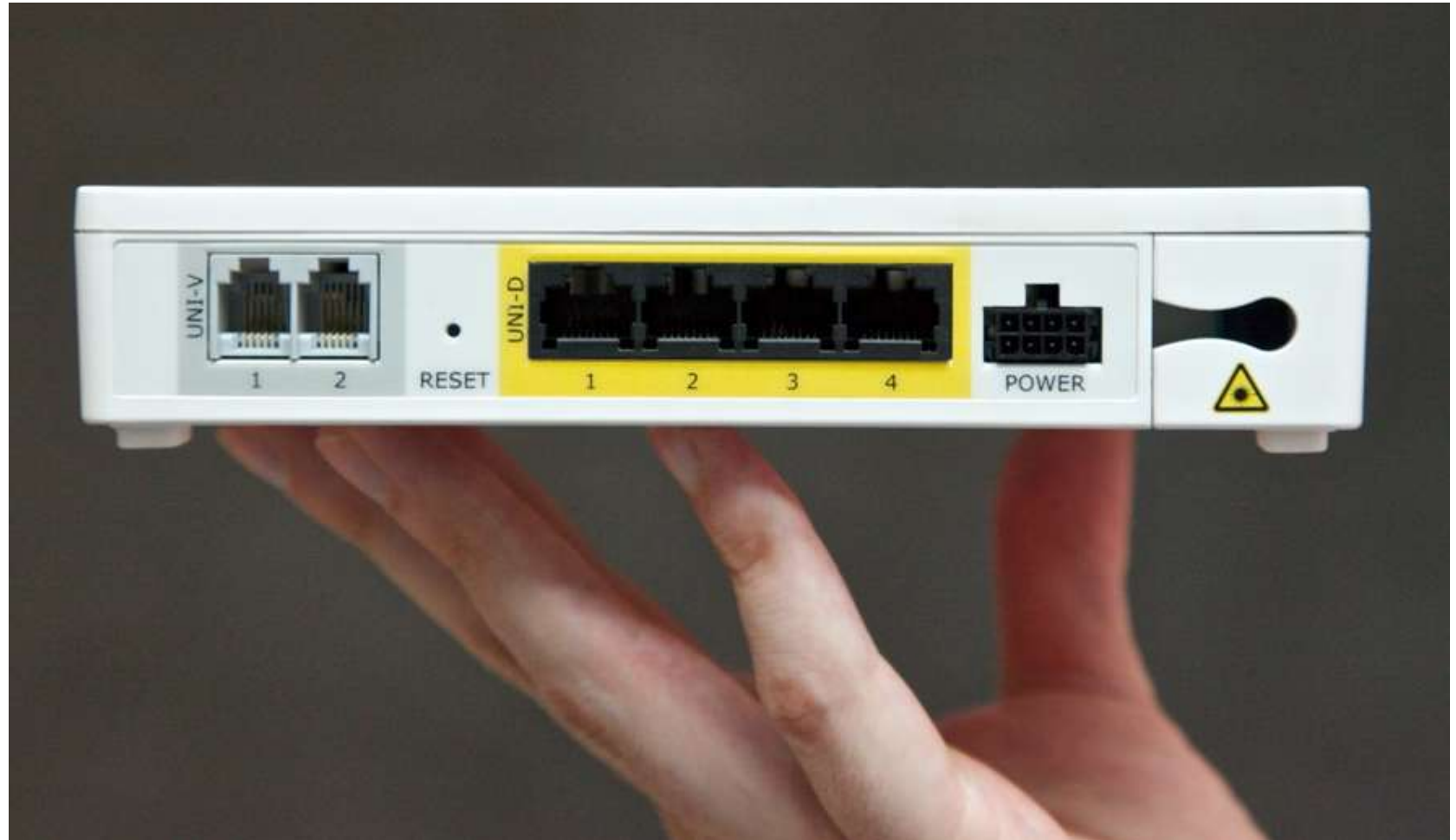

The information on this page/document may no longer be current and is provided for educational and historical purposes. **You should not rely solely on this information.**

NTD - NETWORK TERMINATION DEVICE

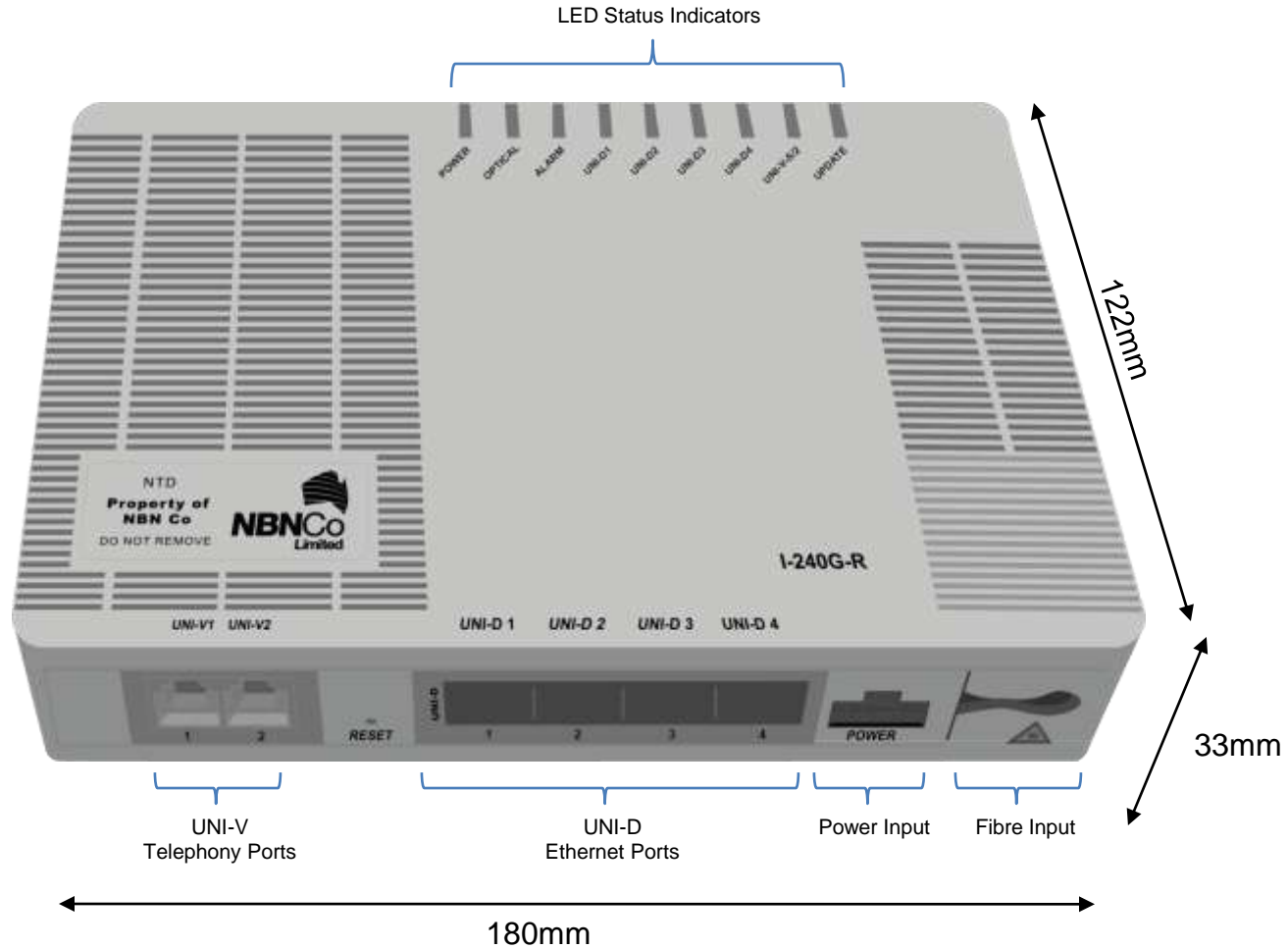

The information on this page/document may no longer be current and is provided for educational and historical purposes. **You should not rely solely on this information.**

Network Termination Device Connection



The information on this page/document may no longer be current and is provided for educational and historical purposes. **You should not rely solely on this information.**



NBNCo